

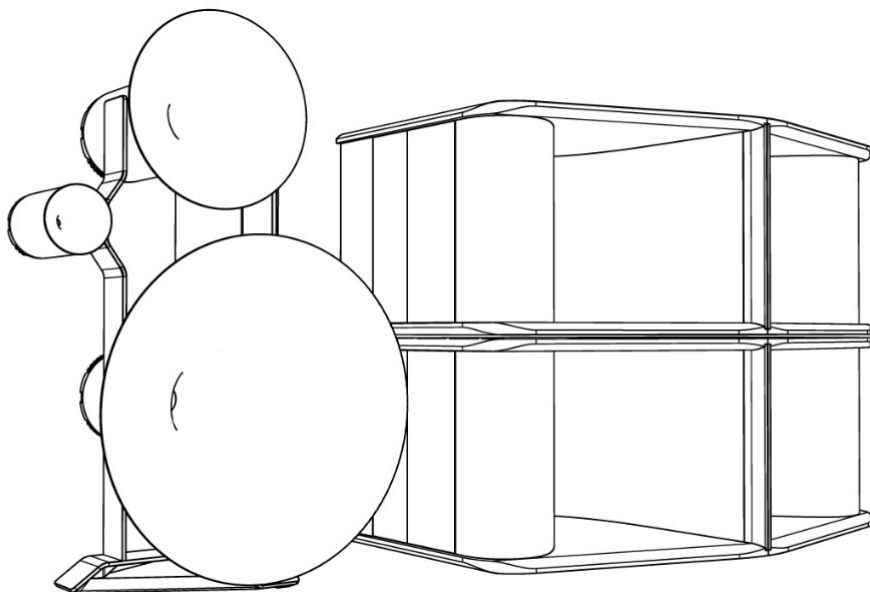

avantgarde
ACOUSTIC



User Manual

TRIO G3 & SPACEHORN

Version 2.0

Listen & Love

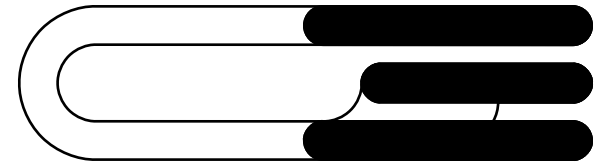

TABLE OF CONTENTS

<u>SAFETY INFORMATION</u>	
SAFETY INFORMATION	6
PRECAUTIONS ON INSTALLATION	7
OPERATING VOLTAGE	7
<u>SET UP</u>	
CONTENT OF PACKAGES	8
UNPACKING	10
ADJUSTABLE FEET	12
ROOM PLACEMENT SPACEHORN	14
<u>OPERATION TRIO G3</u>	
SAFETY PRECAUTIONS	16
PREPARATION BEFORE CONNECTION	16
CONNECTION PASSIVE VERSION – SINGLE WIRING	18
CONNECTION PASSIVE VERSION – TRI WIRING	19
CONNECTION ITRON VERSION – BALANCED XLR	20
OPERATION ITRON – POWER MODES	21
OPERATION ITRON – AUDIO SOUND ADJUSTMENTS	22
OPERATION ITRON – GAIN ADJUSTMENTS	23
<u>OPERATION SPACEHORN</u>	
SPEAKER LEVEL INPUTS	24
BALANCED INPUTS	25
POWER MODES	26
SPEAKER LEVEL INPUT	27
LED BRIGHTNESS CONTROL	27
DSP VOLUME CONTROL	28
DSP SOFTWARE INSTALLATION	29
DSP USER INTERFACE	30
DSP SETTINGS	31
<u>FINE TUNING</u>	
ROOM PLACEMENT	32
TOE-IN & TOE-OUT, LISTENING HEIGHT	33
AMBIENT-SWITCH	34
<u>MISCELLANEOUS</u>	
12V DC TRIGGER	35
E-FUSE	35
FUTURE UPGRADES	35
CLEANING	36
WARRANTY	37



SAFETY INFORMATION

CAUTION



To prevent fire, shock or damage, do not expose the components to rain or moisture.



Conditions for operation:

room temperature 5 – 35° C
humidity 10 – 75%

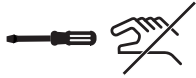

It is intended to alert the user of the presence of uninsulated “dangerous voltage” within the products enclosure. To avoid electrical shock, do not open the cabinet of the components.



Excessive sound pressure levels might cause serious damage to your health. Do not turn up the volume of the loudspeaker system too loud!

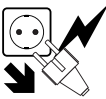

Should any solid object or liquid fall into the cabinet of the components, unplug the unit and have it checked by qualified personnel before operating it any further.



Unplug the components of your system from the wall outlet and antenna if they are not to be used for an extended period of time. To disconnect the power cord, always pull on the plug and never on the cord directly. Never touch the plugs with wet hands.



Only have the system installed and repaired by authorized personnel.

These loudspeakers are designed for the playback of audio signals.
PRIVATE USE ONLY Any misuse, especially commercial operation, will invalidate the warranty.



SAFETY INFORMATION

PRECAUTIONS ON INSTALLATION

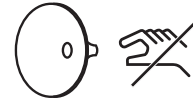

Do not carry the speakers by the horns.



Place the loudspeakers on a flat floor with a load-bearing capacity that adequately supports the weight of the loudspeakers.



To prevent internal heat build-up in the components, place units in a location with sufficient air circulation. Do not install the speakers in a location near heat sources such as radiators, or in a place subject to direct sunlight, excessive dust, or mechanical vibration.



Connect everything securely. Always insert the cables and plugs fully into the jacks. A loose connection may cause hum pick-up and can damage the system. Use only high-quality cables with self-tightening banana speaker and RCA or XLR plugs.

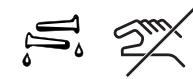

To avoid damaging the finish, never use alcohol, paint thinner or aggressive cleaners to clean the components.



Read this operators manual thoroughly before operating the speaker system.

OPERATING VOLTAGE





The amplifier can be powered from main voltages of 90-250 volts with a mains frequency of 50-60 Hz.

CONTENT OF PACKAGES

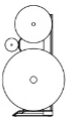
TRIO G3

2 x  wooden crates with one speaker in each.

6 x  Protective discs (with center countersink) for the TRIO G3 spikes to protect pressure-sensitive floors from damage.

2 x  power cords (3m)* *(Trio Itron version only)*

1 x  lubricating oil incl. sponge

1 x  allen key for unscrewing the cover of the connection area.

1 x  user manual (covering Trio G3 & SpaceHorn)

CONTENT OF PACKAGES

SPACEHORN G3

2 x
4 x
6 x  wooden crates* with one SpaceHorn in each.

2 x
4 x
6 x  power cords (3m)*

2 x
4 x
6 x  speaker cable* between Trio G3 and SpaceHorns no. 1 & 2
speaker cable* to connect SpaceHorns no. 1 & 2 with no. 3 & 4
speaker cable* to connect SpaceHorns no. 3 & 4 with no. 5 & 6
(Trio G3 passive version with SpaceHorns only)

2 x
4 x
6 x  XLR cable* between Trio G3 and SpaceHorns no. 1 & 2
XLR cable* to connect SpaceHorns no. 1 & 2 with no. 3 & 4
XLR cable* to connect SpaceHorns no. 3 & 4 with no. 5 & 6
(Trio G3 Itron version with SpaceHorns only)

1 x  height adjustment tool to adjust the leveling feet of the SpaceHorns.

1 x  triangle tool to remove the upper metal covers of the SpaceHorns.

* the number of SpaceHorns & cables depend on the number of SpaceHorns ordered.

UNPACKING

TRIO G3



When unpacking and setting up the speaker, be aware of their heavy weight! For this work we strongly recommend the assistance of at least three or more persons!



Do not move or carry the speakers by holding the horn assembly. The horns & the phase alignment slider of the tweeter may get damaged.

- ① Unscrew and remove top cover of the wooden crate. Note, that the screws may be hidden under the red "caution"-tape.
- ② Unscrew and remove the side panels of the wooden crate.
- ③ Pull the speaker by its base from its padded bearing surface until its balance point is noticeably outside the bearing surface. Now the base frame can be lowered onto a wheeled board and the loudspeaker can be carefully brought into the vertical position.
- ④ Use a wheel board (min. size 70 x 70cm) to transport the speaker to its listening position. Note, that the spherical horns can be removed by unscrewing them counterclockwise. This makes it easier to pass through narrow doorways.

UNPACKING

SPACEHORN

- ① Unscrew and remove top cover of the wooden crate. Note, that the screws may be hidden under the red "caution" tape.
- ② Unscrew and remove the side panels of the wooden crate.
- ③ Lift the SpaceHorn high enough (one person at each corner) so that you can safely carry it and set it down on a wide enough wheel board.
- ④ Use wheel board (min. size 70 x 70cm) to transport the speaker to its listening position.

ADJUSTABLE FEET

TRIO G3

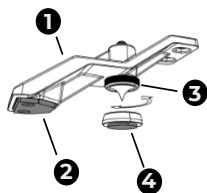

The Trio G3 stands on 3 spike absorber elements ❶ with integrated synthetic-felt pads ❷ to protect the underside of the base frame during speaker placement and alignment.

The spikes ❸ are in the accessories box and can be screwed in from below at the position shown here. To do this, tilt the speaker over one side of the base frame at a time and completely screw in the spike into the now raised absorber element.

Then unscrew the spikes by hand until they lift the speaker and thus decouple it from the floor. Depending on the floor covering, place the floor protection disks ❹ underneath beforehand if necessary. By unscrewing the individual spikes to varying degrees, the speakers can also be precisely aligned vertically to the listening position.

ADJUSTABLE FEET

SPACEHORN

The SpaceHorn is shipped with the 4 x adjustable gliding feet mounted on the bottom plate of the speaker body for a horizontal placement of the SpaceHorn (see graph 1 to 3, next page).

- ❶ If the SpaceHorns are placed vertically (see graph 4 to 7, next page) the gliding feet need to be relocated. Carefully tilt the SpaceHorn to the narrow backside of the speaker, so that both the 4 x gliding feet and the 4 x metal covers become accessible. Use a soft underlay (eg. blanket) not to scratch the speaker body.



- ❷ Use the triangle tool to remove the metal covers of the SpaceHorns.
- ❸ Now swap the positions of the 4 x gliding feet and the 4 x metal covers.
- ❹ Place the SpaceHorns to the final listening position.



- ❺ Use the height adjustment tool (stell rod) to adjust the gliding feet of the SpaceHorns.

ROOM PLACEMENT

SPACEHORN

The Trio system is available in a variety of subwoofer configurations & combinations thereof:

2 x SpaceHorn SingleDrive or TwinDrive

4 x SpaceHorn SingleDrive or TwinDrive

6 x SpaceHorn SingleDrive or TwinDrive

The positioning of the subwoofers mostly depends on the geometry, existing furniture and the interior design criteria of the room.

The following images show various options and examples of different positioning options.

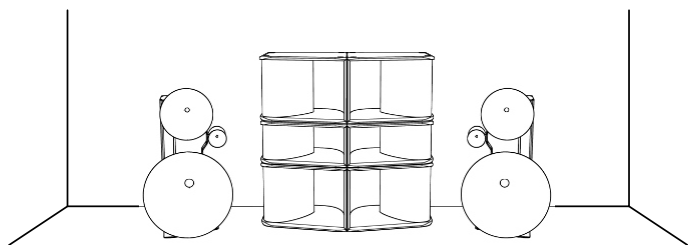

Example 1

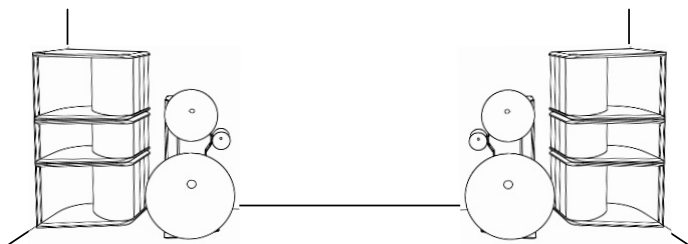

Example 2

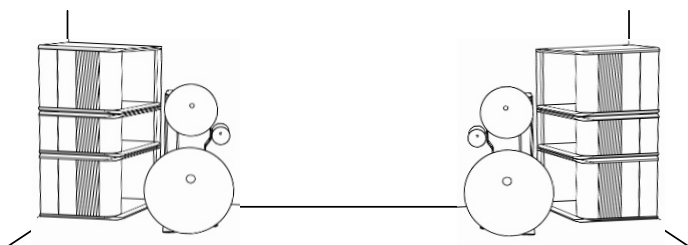

Example 3

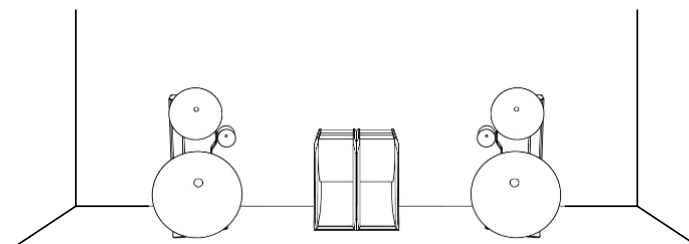

Example 4

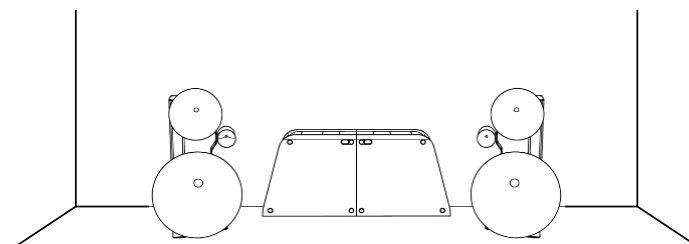

Example 5

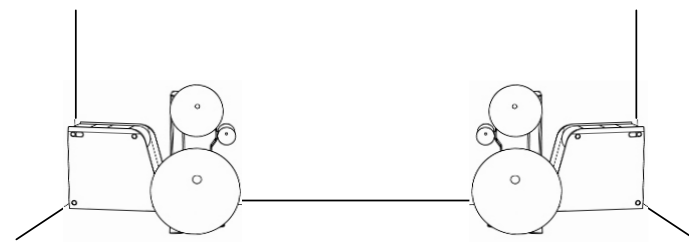

Example 6

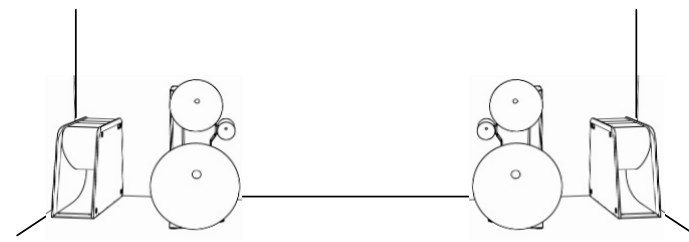

Example 7



SAFETY PRECAUTIONS

ON INSTALLATION



The power to all components must be switched "off" (or disconnected from the household AC) before making any audio connections.



To prevent malfunction/defects, never operate components with unassigned input sockets (unwired)!



Control the polarity of speaker cables! Never mix up "+" and "-". Wrong polarity will deteriorate the sound quality and can damage amplifiers and the active power module of the subwoofer.

Do not short circuit the +/- electric poles of the speaker cables.

Use high quality cable with solid speaker plugs (spades, bananas etc).

PREPARATION BEFORE CONNECTION

TRIO G3

- ① Unscrew and remove the Connection Area Cover ②
- ② Remove the Cable Duct Cover ⑤ which is held by 4 x clip fasteners ④ by gently pushing the cover outwards from behind, using your fingertips through the Cable Duct Opening ⑥

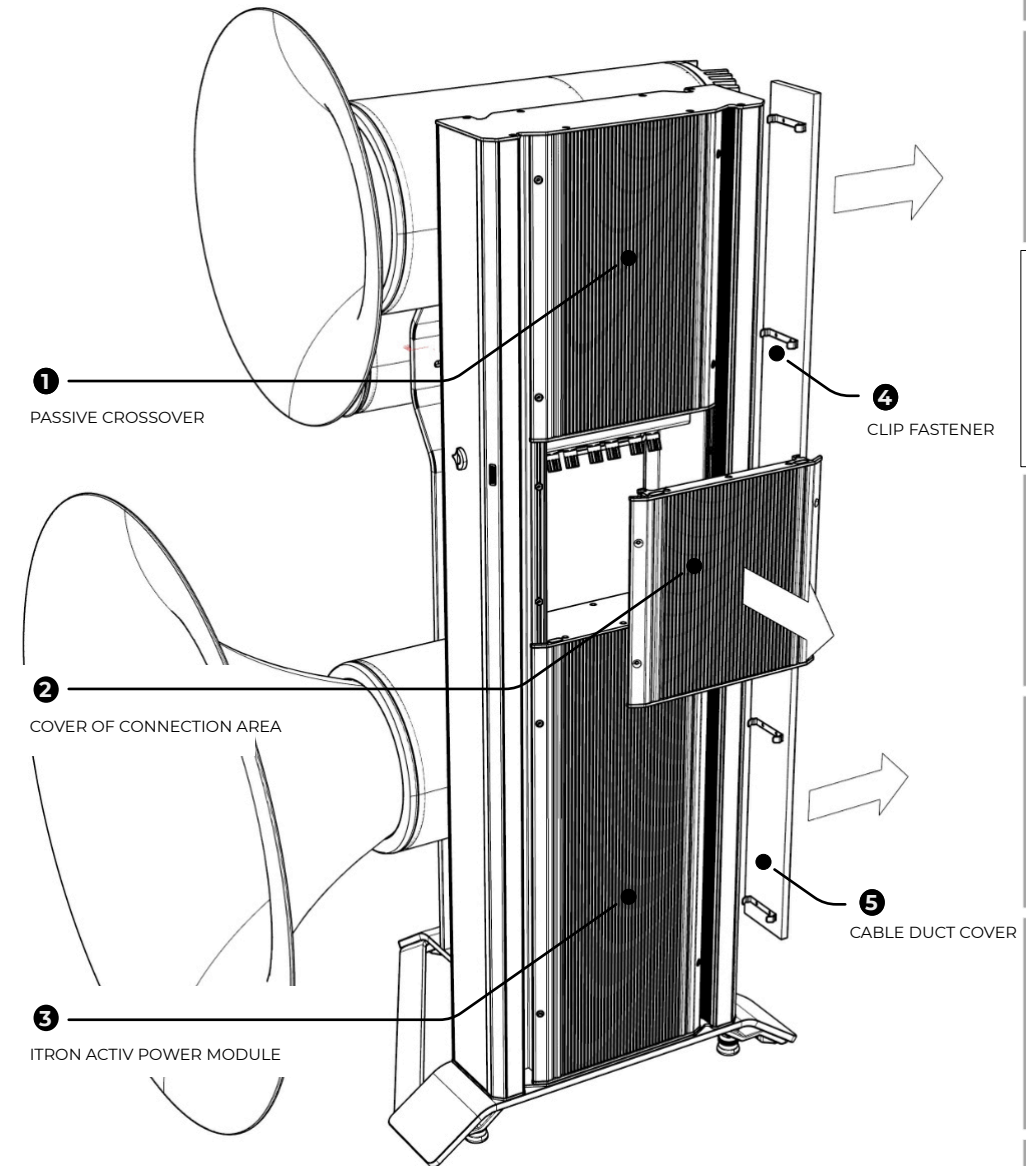
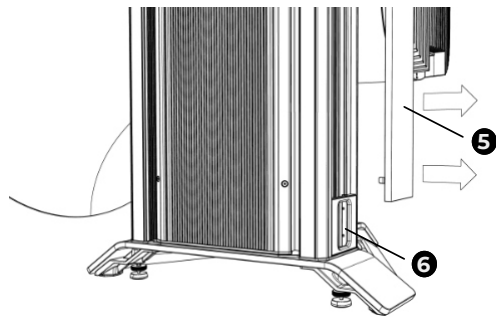

CONNECTION – TRIO G3 PASSIVE VERSION

SINGLE-WIRING

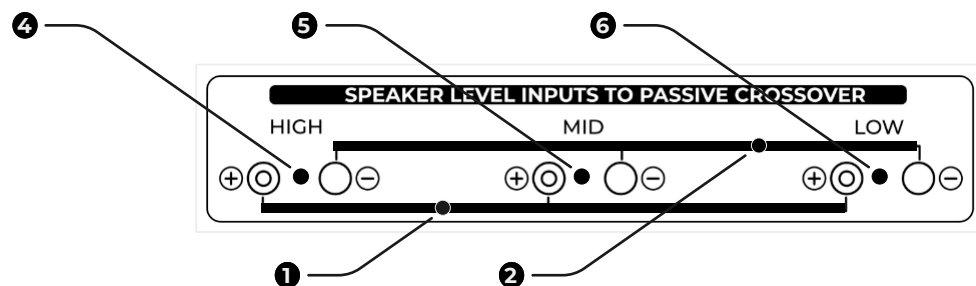

Tweeter **4**, midrange **5** and lowrange **6** drivers have dedicated speaker terminals. In the standard configuration, these terminals are interconnected with 2 x OFC Trident Bridges **1** & **2**. One bridge **1** interconnects all “+” connectors, the other one **2** all “-” connectors.

- 1 Connect the speaker terminal **4** of the TRIO G3 speakers and the speaker-level input terminal of the SPACEHORNS with the long jumper cable. The jumper cable is included in the accessory box.
- 2 If you use more than 1 x subwoofer per channel, connect speaker-level input terminal of the SPACEHORNS No.1 and speaker-level input terminal of the SPACEHORNS No.2 with the shorter jumper cable. The jumper cable is included in the accessory box.

🔑 The jumper cables have hollow banana plugs which are open at the rear. This way it is possible to stack multiple speaker cables to the same speaker terminal.

- 3 Connect the Speaker-Output of your power (or integrated) amplifier with the speaker MID terminal **5** of the TRIO G3 speakers.
- 4 Only now, connect the AC power cords of the components to a mains socket (90-250 V) and switch on the subwoofer and the other devices.

🔑 The cable at the INTERNAL CONNECT PORT is a non-serviceable internal connection! Do not unplug.

CONNECTION – TRIO G3 PASSIVE VERSION

TRI-WIRING

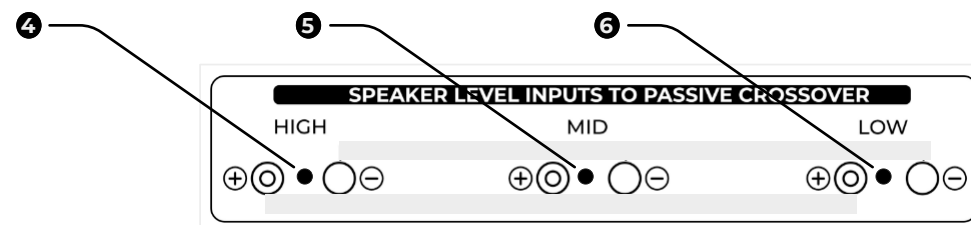

To operate the system in TRI-Wiring or TRI-Amping mode, the 2 x OFC Trident Bridges **1** & **2** need to be removed.

- 1 Open the screw caps of Tweeter **4**, midrange **5** and lowrange **6** speaker terminals and remove the two OFC Trident Bridges **1** & **2**.
- 2 Connect the Speaker-Output of your power (or integrated) amplifier with the speaker terminals **4** **5** **6** of the TRIO G3 speakers using a dedicated cable for each connection. The same applies when using multiple amplifiers for treble, midrange and bass.

CONNECTION – TRIO G3 ITRON VERSION

BALANCED XLR CONNECTION

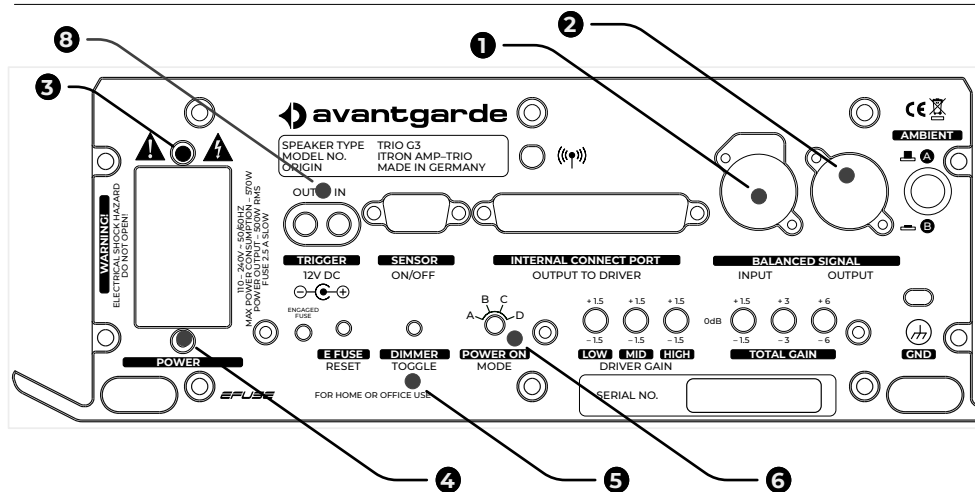

Line level connections feature balanced XLR connectors/terminals. The pin assignment of these follows the EIA RS-297-A standard: PIN 1 = GND, PIN 2 = HOT, PIN 3 = COLD. Never use cables with differing pin assignment! This will deteriorate the sound quality and can damage the amplifiers and/or the active power modules of the subwoofers.

- ① Connect the volume-controlled line-level output of your preamplifier to the balanced line-level input **1** of the TRIO G3 speaker with an XLR cable.
- ② Connect the balanced XLR output **2** of the TRIO G3 speaker and the balanced XLR input of the SPACEHORNS with the long XLR jumper cable. The jumper cable is included in the accessory box.
- ③ If you use more than 1 x subwoofer per channel, connect the balanced XLR output of the SPACEHORNS No.1 and the balanced XLR line level input of the SPACEHORNS No.2 with the shorter XLR jumper cable. The jumper cable is included in the accessory box.
- ④ Only now, connect the AC power **3** of the components to a household AC outlet and turn on the ITRON module and the subwoofer.

OPERATION – TRIO G3 ITRON VERSION

POWER MODES

- ① The mains power switch **4** has an “O” OFF-position & an “I” ON-position. For operation switch to the ON position.
- ② The TRIO G3 features an illuminated sensor switch **7** on its front side to turn the speaker ON.

ORANGE light = STANDBY

WHITE light = ON

PURPLE light = OTA firmware update (*optional future upgrade only*)

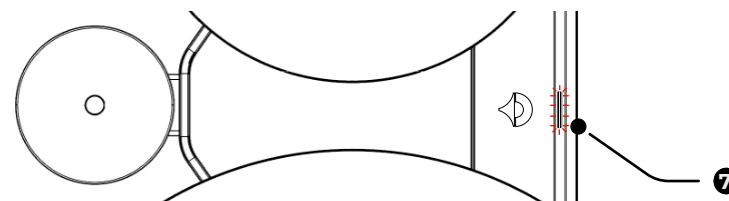

The brightness of the light can be adjusted with the DIMMER TOGGLE button **5**, toggling through 8 x intensities.

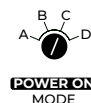

- ③ 4 x different power ON/OFF modes can be selected with the POWER ON mode selector **6**. Use a screwdriver to switch the modes.

☛ newly selected modes will only become active after the mains power switch **4** has been shortly switched OFF & ON again.

MODE A

speaker is ON upon powering it up with the mains power switch **4**. To be used for remote controlled AC power sockets. The frontal sensor switch **7** may still be used to switch into standby mode, but upon next power cycle the speaker will turn ON again directly.

MODE B

speaker is ON when a 12VDC remote switch-on voltage is detected at the remote-trigger socket **8**. The speaker switches OFF automatically when the 12V trigger voltage is switched OFF.

MODE C

the frontal sensor switch **7** is used to toggle between speaker ON & STANDBY.

MODE D

speaker is switched ON & STANDBY by remote control signal (*optional future upgrade only*).

OPERATION – TRIO G3 ITRON VERSION

AUDIO SOUND ADJUSTMENTS

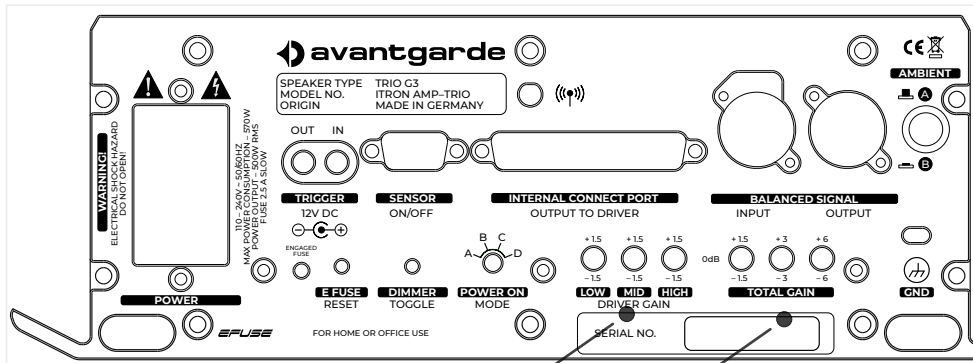

1

2

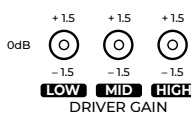

The 3 x DRIVER GAIN switches ❶ allow the setting of individual volume correction of the 3 horns in -1.5 dB, 0 dB (= FLAT) and +1.5 dB steps.

- LOW adjusts the level of the lowrange horn (100–600 Hz)
- MID adjusts the level of the midrange horn (600–4.000 Hz)
- HIGH adjusts the level of the tweeter horn (above 4.000 Hz)

Factory default is the “0 dB” position for all 3 switches.

Adjustments may be made according to personal taste, for adapting to the tonal “brightness” (or lack thereof) of connected source equipment, or to mildly correct room acoustic influence.

In practice, the tonal balance between the 3 x frequency bands can be altered up by up to 3 dB. For example:

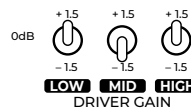

With the HIGH and LOW switches set to +1.5 dB, and the MID switch set to -1.5 dB, the relative volume of the midrange is reduced by 3 dB against the tweeter and lowrange horns. This could be used as a favorable voicing for “shouty” recordings (with over-emphasized midrange frequency content) or in an acoustical environment that has a “peak” in the midrange.

OPERATION – TRIO G3 ITRON VERSION

GAIN ADJUSTMENTS

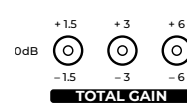

The 3 x TOTAL GAIN switches ❷ allow the adjustment of the gain of the speakers to the strength of the line level signal from the connected preamp. To avoid sound degrading potentiometers in the signal path, 3 x switches in an additive stepped arrangement are being used. Factory default is the “0 dB” position for all 3 switches.

Practical example: If a preamp already makes big “jumps” in sound level by turning the volume knob just slightly, reducing the iTRON’s input gain by up to -10.5 dB may increase the adjustment angle of the pre amps volume knob considerably, thus enhancing its practical usefulness for fine volume adjustments.

The following steps are possible:

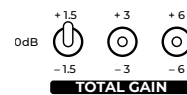

+/- 1.5 dB = left switch in “+” or “-” position

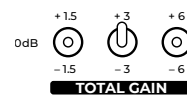

+/- 3 dB = central switch in “+” or “-” position

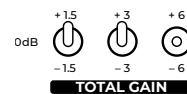

+/- 4.5 dB = central & left in “+” or “-” position

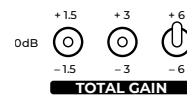

+/- 6 dB = right switch in “+” or “-” position

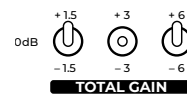

+/- 7.5 dB = right & left in “+” or “-” position

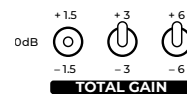

+/- 9 dB = right & central in “+” or “-” position

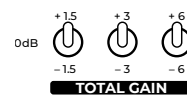

+/- 10.5 dB = all 3 switches in “+” or “-” position

CONNECTION - SPACEHORN

SPEAKER LEVEL INPUT

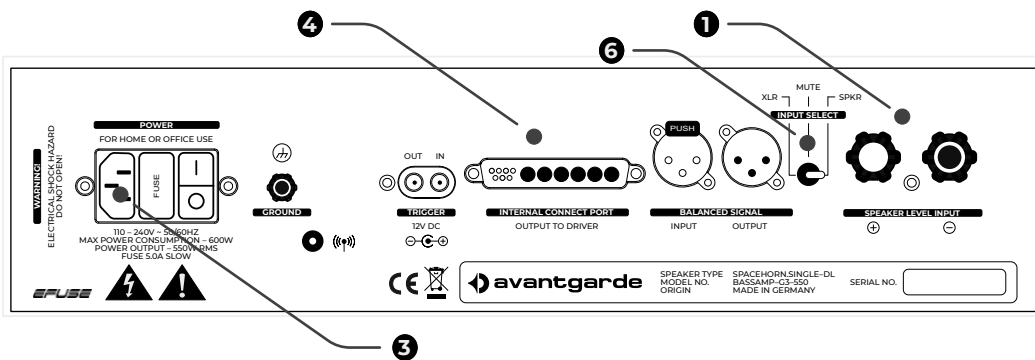

① Connect the speaker terminal of the TRIO G3 speakers and the speaker-level input terminal of the SPACEHORNS ① with the long jumper cable. The jumper cable is included in the accessory box. Switch Input Select ⑥ to SPKR input.

② If you use more than 1 x subwoofer per channel, connect speaker-level input terminal ① of the SPACEHORNS No.1 and speaker-level input terminal of the SPACEHORNS No.2 with the shorter jumper cable. The jumper cable is included in the accessory box.

👉 The jumper cables have hollow banana plugs which are open at the rear. This way it is possible to stack multiple speaker cables to the same speaker terminal.

③ Only now, connect the AC power cords ③ of the components to a household AC outlet and turn on the subwoofer and the other equipment.

👉 The cable at the INTERNAL CONNECT PORT ④ is a non-serviceable internal connection! Do not unplug.

CONNECTION - SPACEHORN

BALANCED INPUT

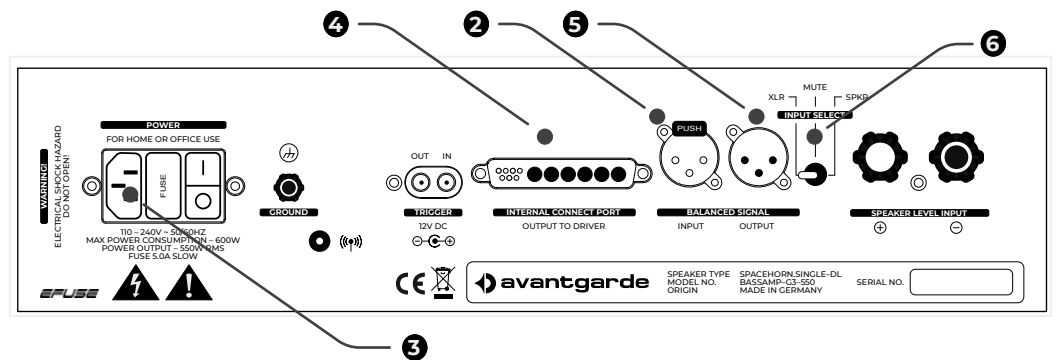

Line level connections feature balanced XLR connectors/terminals. The pin assignment of these follows the EIA RS-297-A standard: PIN 1 = GND, PIN 2 = HOT, PIN 3 = COLD. Never use cables with differing pin assignment! This will deteriorate the sound quality and can damage the amplifiers and/or the active power modules of the subwoofers.

① The SpaceHorn receives the music signal either directly from the preamplifier (if the preamplifier has a second pair of volume controlled line level outputs) or, as a looped signal, from the BALANCED SIGNAL OUTPUT of the ITRON module of the TRIO G3, at the jack ②. Switch the Input Select ⑥ to the XLR position.

② If you use more than one subwoofer per channel, connect the balanced XLR output ⑤ of the SPACEHORNS No.1 and the corresponding XLR input ② of the SPACEHORNS No.2 with one of the shorter XLR jumper cable from the accessory box.

③ Only now, connect the power cables of the components ③ to a mains socket and turn on the subwoofer and the other equipment.

👉 The cable at the INTERNAL CONNECT PORT ④ is an internal connection to the speaker chassis! It is absolutely necessary to keep this connection! Plugged at all time!

OPERATION - SPACEHORN

POWER MODES

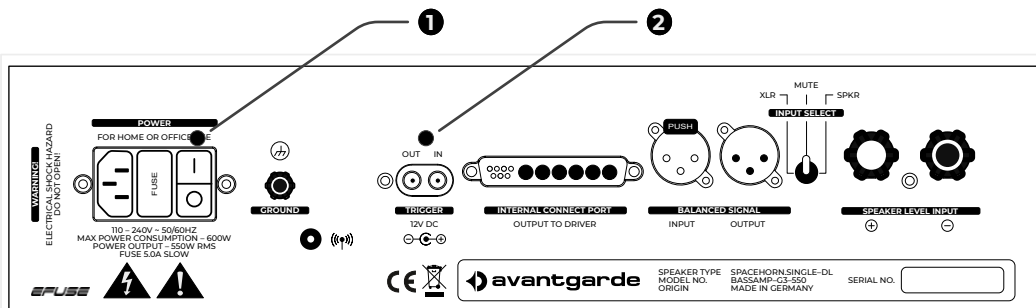

① The mains power switch ① has an “O” OFF-position & an “1” ON-position. For operation switch to the ON position. If the SPACEHORN is not being used for a longer time, switch the system to the “0” OFF-position.

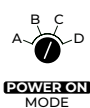

② 4 x different power ON/OFF modes can be selected with the POWER ON mode selector ⑥ which is located on the outer side of the amplifier heatsink. Use a screwdriver to switch the modes.

newly selected modes will only become active after the mains power switch ① has been switched OFF & ON again.

MODE A speaker is ON upon powering it up with the mains power switch ①. To be used for remote controlled AC power sockets.

MODE B speaker is ON when a 12VDC trigger voltage is detected at the remote-trigger socket ②. The speaker will automatically switch OFF, when the 12V trigger voltage is switched OFF.

MODE C the sensor switch ⑦ which is located on the outer side of amplifier heatsink is used to toggle between speaker ON & STANDBY. To be used for remote controlled AC power sockets.

MODE D speaker is switched ON & STANDBY by remote control signal (optional future upgrade only).

OPERATION - SPACEHORN

SPEAKER LEVEL INPUT

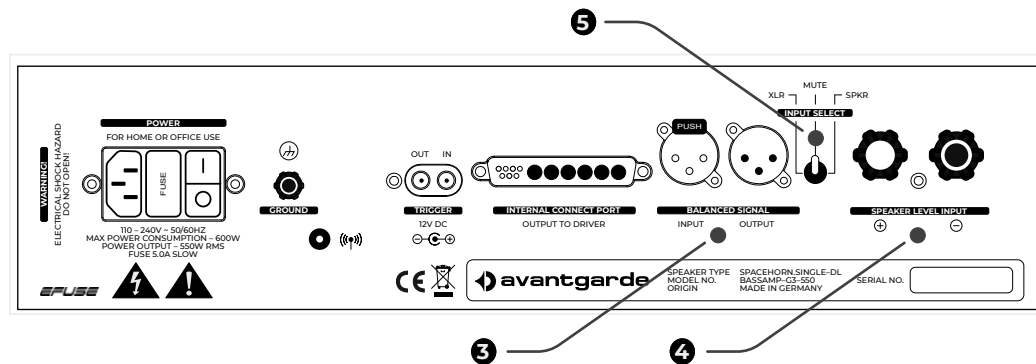

① Cables can be connected to the speaker (Speaker Level) and XLR inputs (Balanced Signal) ④ & ⑤ at the same time. The Input-Select switch ⑤ can be used to switch between the inputs.

② The Input-Select switch ⑤ also has a MUTE-position, which mutes the inputs. This can be helpful during troubleshooting (e.g. when hum occurs).

OPERATION - SPACEHORN

LED BRIGHTNESS CONTROL

The brightness of the LED light can be adjusted with the DIMMER TOGGLE button ⑦, toggling through 8 x intensities.

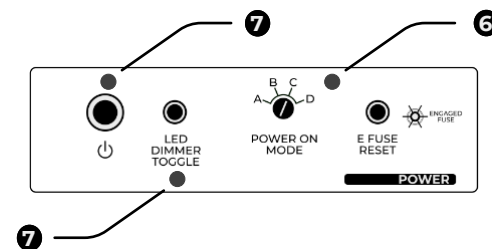

OPERATION - SPACEHORN

DSP VOLUME CONTROL

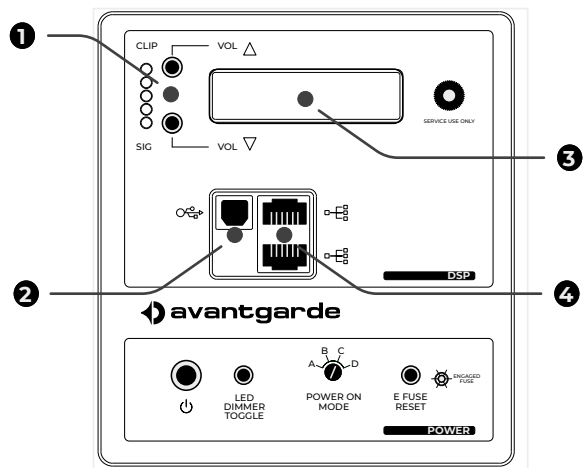

The bass response of the speaker will be influenced by the room and the position of the speaker. This might cause the bass response of the speaker to be strengthened or weakened. Thus as the first step, the overall bass volume needs to be aligned to compensate these effects.

- 1 Press the VOL ▲-button 1 to increase or the VOL ▼-button 1 to reduce the volume of the bass response. The set volume is shown in the display 3 in 0.5 dB steps (from -36 to +24 dB).

OPERATION - SPACEHORN

DSP SOFTWARE INSTALLATION

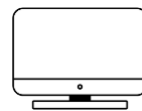

Additional settings can be programmed with the Avantgarde Control software.

The corresponding software, for Windows and MacOS can be downloaded from the website: www.avantgarde-acoustic.de

LAN CONNECTION TO PC

- 1 Each SPACEHORN amplifier features 2 x LAN sockets which allow daisy-chaining of multiple subwoofers via LAN cable.
- 2 Connect the LAN ports 4 of all SPACEHORNS with each other using LAN-cable (type CAT5/6/7/8).

Connect a free LAN port 4 of one SPACEHORN with the LAN port of your computer or with the LAN port of your WIFI router. The Avantgarde Control software installed on your computer/laptop will automatically detect and display all available subwoofer amps.

USB CONNECTION TO PC

- 1 The USB port 2 is reserved exclusively for service application by the manufacturer.

IMPORTANT!



The LAN and the USB connectors are not suitable for the connection of music sources!

OPERATION - SPACEHORN

DSP USER INTERFACE

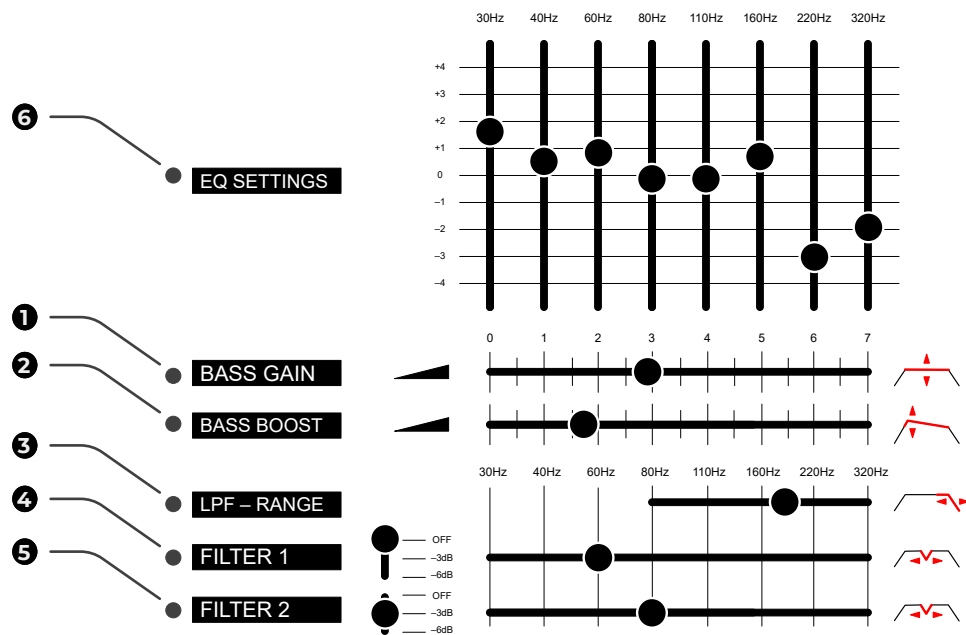

The above picture shows the graphical user interface that is available for each of the subwoofers individually after installing and starting the software.

⚠ Please note that all changes in the Avantgarde control software immediately become audible in the speaker. This way it is easy to verify the changes by listening and fine adjust if required.

OPERATION - SPACEHORN

DSP SETTINGS

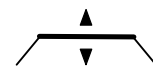

The BASS GAIN slider ① sets the overall volume of the subwoofer.



The BASS BOOST slider ② increases the low frequency response below 45 Hz. This allows to tailor the bass response from “linear” to “fat”.



For individual frequency settings use the 8 x band equalizer ⑥. Each of the 8 bands can be increased or decreased by up to 4dB. This can be used to tailor your bass response to specific sounds (linear, techno, disco, pop, etc.) or to reduce some wide-band room resonances.

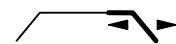

The LPF-RANGE slider ③ sets the upper crossover frequency of the subwoofer. In the factory setting the crossover frequency is optimized for a linear transition, the frequency response of the subwoofer blends seamlessly into the frequency response of the midrange horn. The crossover frequency can be used to adjust the “tonal balance” of the system.

- ① When set to a higher frequency, the subwoofer will partly overlap with the midrange horn response. This will add “warmth” and give a richer “body” to the sound character of certain voices and instruments.
- ② If the crossover frequency is purposely set to a lower frequency, subwoofer and midrange frequency response will have a small gap. The tonal balance of the system will shift to a more horn typical “dynamic” and “punchy” sound.



FILTER 1 & 2 ④&⑤ are narrow band “notch” filters with a negative gain of -3dB or -6dB. These filters can be used to eliminate/reduce unwanted narrow band resonance frequencies of the room.

- ① Use commonly available frequency sweep apps to detect the position (Hz) of possibly occurring room resonances. Or play bass heavy music through your system and slowly slide the FILTER set at -6dB upwards until the “boominess” improves.

FINE TUNING

ROOM PLACEMENT

We recommend to place both speakers with the tweeter facing to the inside. This setup reflects the high-frequency and imaging precision with maximum stability into the center of the room or in the direction of the ideal listening position.

Due to the controlled dispersion characteristics of the horns the speaker will excite less unwanted reflections from the room walls compared to conventional speakers. Thus they can be positioned closely to back walls or corners (both or only one speaker in the corner!).

Choose a position for the speakers (tweeter facing to the inside) in your listening room. Both speakers and your listening seat should form an approx. equilateral triangle. Ideally each side of the triangle should be approx. 3,0 – 4,0m.

The speakers should be toed-in with the midrange horns pointing directly to the listening position.

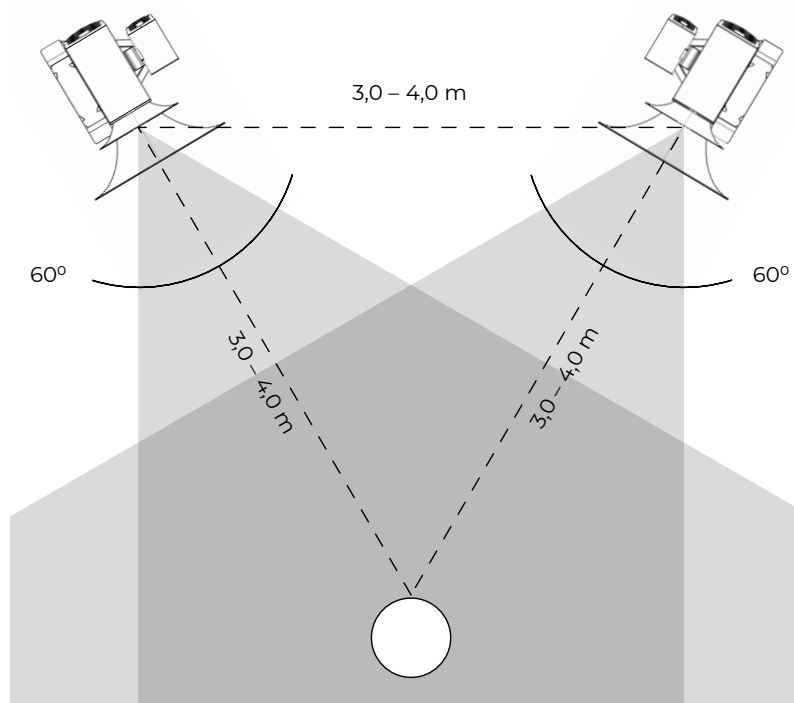

FINE TUNING

TOE-IN & TOE OUT

By facing the speakers inwards (toeing-in) or outwards (toeing-out) you can further affect the focus and tonal balance of the system.

By toeing-out, the sound appears to be less “direct” or “forward sounding”, but this may affect the focus of the centre image.

Toeing-in emphasizes increased focus on the centre image, but may affect the width of the stereo image.

As the tweeter is located outside of the centre axis of the speaker, toeing-in will increase its distance to the listener in relation to the acoustical centre of the low & midrange horn. Toeing-out will decrease its distance.

In order to compensate for this acoustical runtime differences the tweeter can be moved forward when toeing-in and moved backwards when toeing-out. The correct offset of the tweeter is always 48,5 cm.

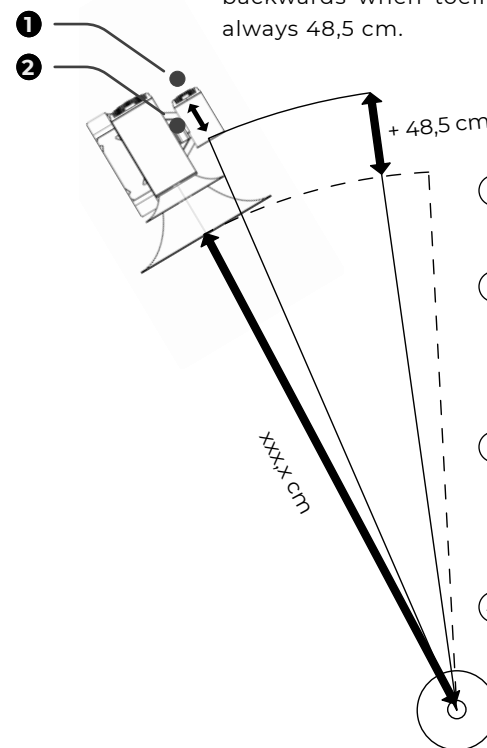

- ① Choose your favorite toe-in or toe-out position.
- ② Take a cord and measure the distance (xxx,x cm) from your listening position to the centre top rim of the big lowrange horn.
- ③ Take this length (xxx,x cm) and add 48,5 cm. This is the correct distance from your listening position to the centre top rim of the tweeter horn.
- ④ Loosen the knurled knob ② to release the tweeter and move the tweeter ① forward or backward respectively.

FINE TUNING

LISTENING HEIGHT

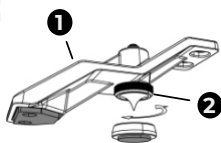

Depending on the listening distance and the height of your seat it might be important to raise or lower the speaker systems. Ideally your ears are in level with the height of the centre of the tweeter (approx. 110 cm above ground).

If not, slightly incline the speaker forward or backward by turning the knurled screw **2** of the spike assembly **1** until the tweeter is pointing at you.

AMBIENT-BUTTON

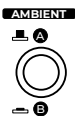

The ambient-button can be used to moderately adjust the tonality of the speakers in heavily damped rooms.

POSITION **A**

Standard position for normal to slightly damped rooms.

POSITION **B**

Position for normal to highly damped rooms.

RUN-IN TIME

Brand new horns and subwoofers usually need at least 40 hours of running-in. During this period sound quality will improve continuously. Please leave the subwoofers ON during this run-in period.

After this run-in, the sound might have been altered and it might be necessary to slightly re-tune the system set-up (positioning and subwoofer-settings).

WARM-UP TIME FOR ITRON

The ITRON electronics uses pure CLASS-A circuits with Zero-Feedback. To reach its full sonic potential the components need to be fully warmed-up. A sufficient warm up time (> 15 minutes) prior to serious listening is recommended.

MISCELLANEOUS

12V DC TRIGGER

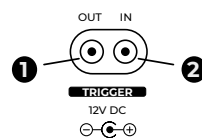

The 12V DC TRIGGER sockets of the ITRON & SPACEHORN electronics features an "IN"-socket **1** and an "OUT"-socket **2**. This way it is easily possible to remotely switch ON/OFF additional devices (additional SPACEHORNS etc.) by simply daisy-chain the 12V trigger signal.

Wiring can be made with mono or stereo jack cables.

E-FUSE



All Avantgarde electronics are equipped with a state-of-the-art electronic protection circuit. This E-FUSE continuously monitors the unit and in the event of a fault immediately interrupts the flow of current with unrivaled precision & speed and thus protects the device from damage.

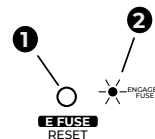

When the E-FUSE has tripped, the current flow will be interrupted and the device stops operating. The red engaged fuse LED **2** will illuminate. Press the E-FUSE RESET button **1** to reset. If the E-FUSE keeps tripping, a permanent malfunction has occurred. Disconnect the device from the mains and get it serviced by your dealer.

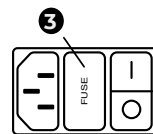

All Avantgarde electronics are equipped with a mains ON-OFF power switch that includes an external fuse holder **3**. To avoid any kind of sound degradation caused by conventional fuses, the accessories include gold-plated copper bolts that can replace the glass fuses used in the factory and thus eliminating any sound degradation at this point. NOTE: The certified final tests during final assembly are performed with glass fuses in place, therefore these are also installed as standard in the delivery status.

For whatever reason this copper bolt may at any time be replaced by a conventional 2.5 amp slow blow glass fuse.

FUTURE UPGRADES *(optional future upgrade only).*



Your system has already been equipped with a wifi antenna port to support future upgrades. This includes remote control signals (from apps etc.) and receiving OTA (over the air) update files for the firmware of the built-in controller chipset.

CLEANING

CLEANING OF HIGH GLOSS LACQUER SURFACES



We recommend to regularly clean high gloss color-coated surfaces (for ex. horns) with a dry soft fabric (duster) or a soft cosmetic brush.

To remove finger prints and dirty spots we recommend the use of glass detergent.

To remove small scratches we recommend the use of automotive waxes and polishing compounds for cars. Please proceed carefully and strictly follow the cleaning instructions of the manufacturer.

- ☛ First apply glass detergent, waxes or polisher on the backside of the horns to test the result!
- ☛ Do not touch the membranes while cleaning the horns!
- ☛ Avoid scratching the horns with dirty fabrics and never use aggressive detergents or abrasives!

CLEANING OF SATIN-FINISHED LACQUER SURFACES



We recommend to regularly clean satin finished color-coated surfaces (for ex. subwoofer body) with a dry soft fabric (duster) or a soft brush.

To remove finger prints and dirty spots we recommend the use of glass detergent.

- ☛ Do not use waxes or polisher!

CLEANING OF METAL SURFACES

Clean the powder coated and anodized surfaces of the frame parts with a regular duster or slightly moisted (i.e. by glass detergent) piece of cloth.

WARRANTY

SPEAKER REGISTRATION

Register your speaker and receive an extension of your factory warranties for 1 year at a time as the first owner.

- ① Please fill out the warranty card:

name:

street:

city:

serial no.

serial no. subwoofer

purchase date:

dealer:

- ② Take a photo of the completed warranty card with your cell phone.
- ③ Send the photo by mail using the QR code to: ["info@avantgarde-acoustic.de"](mailto:info@avantgarde-acoustic.de)



WARRANTY

Avantgarde Acoustic Lautsprechersysteme GmbH warrants that the products are free from defects attributable to faulty manufacture. The warranty is limited to ten (10) years for the stability of the connecting elements (between metal, wood and plastic parts, including the horns), five (5) years for the color coating and the drivers, and two (2) years for all electronic components.

All products Avantgarde Acoustic have been thoroughly checked before shipping. In the case of problems, please check the following:

1. This warranty begins on the date of original purchase and may be enforced only by the original purchaser. Please keep the original dated sales slip as proof of warranty coverage. The warranty period is not effected by warranty services provided within the warranty period.

2. Expect as specified below, this warranty covers all defects in material and workmanship in this product. Our liability for any defective product is limited to repair or replacement of the products, at our option. Any implied warranties, including warranties of merchantabilities and fitness for a particular purpose, or damages based upon inconvenience, loss of use of the product, or commercial loss, or any other damages are not covered by this warranty.

3. Any modification, alterations or changes to the product are strictly prohibited.

4. In case of defects, please contact at first your dealer. If at the sole descretion of Avantgarde Acoustic it is necessary to ship the product to the manufacturer, please make sure that:

- The product is carefully packed and shipped in its original shipping box.
- The Avantgarde Acoustic warranty card is filled out and added to the product or, alternatively the original invoice from the dealer or a proof of online product registration in the Avantgarde Customer Club.
- The product is shipped free of charge to us, e.g. you must pay all shipping charges (ex. Freight, insurance etc.).

WARRANTY

5. The following are not covered by this warranty:

- Regular inspections, tuning, repairs or replacement of parts which are attributable to normal wear and tear.
- Damage occurring during shipment of the product. All transport claims must be presented to the carrier.
- Damages or scratches on the surface of the product (ex. Housing, horns, metal parts, color coating etc.). These claims must be presented within 3 days after the date of original purchase with your dealer.
- Damage resulting from incorrect placement, faulty connections, improper operation. Damage resulting from failure to follow instructions supplied with the product.
- Damage resulting from accident, misuse, abuse, neglect, electrical surges, lightning or other acts of God.
- Damage resulting from repair or attempted repair by anyone other than Avantgarde Acoustic or an authorized Avantgarde Acoustic dealer.
- Consequential, secondary or subsequent damages to other third party appliances.

6. Some states do not allow limitations on how long an implied warranty lasts and/or do not allow the exclusion or limitation of incidental or consequential damages, so the above limitations may not apply to you.

7. Register your new speaker on our website and receive an extension of your factory warranties by 1 year.

www.avantgarde-acoustic.de

Avantgarde Acoustic Lautsprechersysteme GmbH
Nibelungenstr. 349
64686 Lautertal - Reichenbach
Germany



Avantgarde Acoustic GmbH
Nibelungenstrasse 349
D-64686 Lautertal
Germany

Tel: +49.6254.306 100
email: info@avantgarde-acoustic.de
www.avantgarde-acoustic.de